

# 1:18 Full Proportional Remote Control Drive Monster Truck



Caution: This model is not a toy, it is designed for user over 14 years of age.

Please use this instruction and the R/C system instruction at the same time.

The instruction is suitable for a type of model whose number is A979-B.

Safety and caution .....	1
Troubleshooting • Product introduction .....	2
Instruction of common tools and installation the electronic part.....	3
Practice and maintenance.....	4-5
Assemble exploded view .....	6-10
Fittings view .....	11-14

## Safety and Cautions

- \*Never run the model on public roads or streets, as it could endanger traffic.
- \*Never run the model in crowded areas, near or toward people or animals, to prevent property damage and/or personal injury.
- \*Never run the model near rivers, ponds or lakes as to prevent R/C car from dropping into the water.
- \*Make sure that no one else is using the same frequency as yours in your running area. Using the same frequency at the same time, whether it is driving, flying or sailing, can cause loss of control with R/C model, resulting in serious accidents.
- \*To avoid a runaway R/C model or loss of control, always follow the procedure below:
  1. Fully extend transmitter antenna.
  2. Switch on transmitter.
  3. Switch on R/C model.
- \*Follow reverse procedure to shut down.
- \*Never touch or hinder rotating tire.
- \*Never run R/C model in the rain or let run over puddles, as water may cause trouble with R/C model.
- \*Motor and battery get very hot after running. Take care when handle them.
- \*Retract transmitter antenna when not in use.
- \*Remove the batteries from model and transmitter when they are not in use.

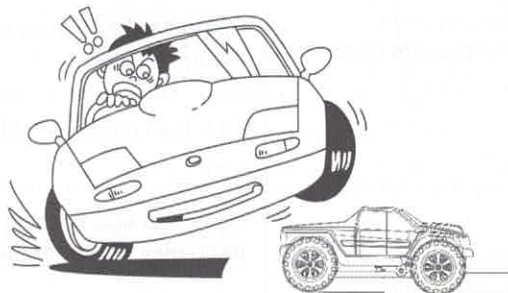

## Cautions when handling batteries

- \*Do not dismantle the battery or charger and do not cut any battery cables. This may cause short-circuit and/or damage to the product.
- \*Change battery with compatible charger following proper procedure that is called out in the instructions. Do not modify charger or charge battery in improper way.
- \*Do not recharge battery that is still warm from use as it may damage the battery. Allow the battery to cool off prior to recharging.
- \*Make sure to disconnect charger cables from R/C model and electric outlet when not in use.
- \*Remove transmitter battery when not using it for a long time as it may leak and damage transmitter when left for a long period.
- \*Never incinerate used batteries, as they can explode causing serious accidents.



## Safety precautions

Do not operate the model on public roads, in crowded places or near infants, it may cause accidents or injury.

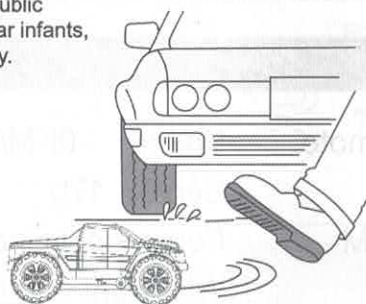

As the product includes small and sharp parts, assemble and store this product only in places out of the reach of children.



As the front end of the antenna may be dangerous, do not aim it toward faces.



During the car running and after, the motor will be hot. Please do not touch it until it has had time to cool down.

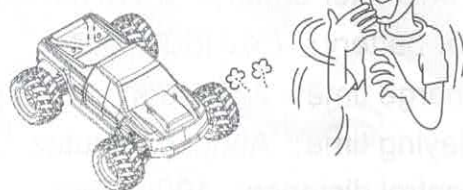

## Troubleshooting

Description	Cause	Solution
The car does not operate at all.	Transmitter or receiver is off.	Turn on both transmitter and receiver.
	Batteries are not placed properly in the transmitter.	Place batteries in the transmitter properly.
	The drive battery is not charged enough.	Charge the drive battery.
The car does not follow your operation and control distance not enough long.	Someone else is using the same radio frequency as you are using.	Change your radio frequency to the one no one else is using, wait until the driver using the same radio frequency finishes driving, or drive your car at a different place.
	There is not enough power in the transmitter or receiver batteries.	Replace the transmitter batteries with new ones and charge the drive battery.
	Not tighten antenna on the transmitter/not fully extend antenna.	Make sure insert antenna into the transmitter and fully extend antenna.



### CAUTION

- \* Please observe the operation manual or packing explanation to install and use, and some parts should be installed by adults.
- \* The product contains small parts, it may cause swallow or choke.
- \* Never run an R/C model in the seep or rain, moisture areas, or it may cause the parts malfunction.
- \* Please throw the wrapper in time to avoid danger for the children.
- \* Regularly examine for damage to the charge, wire, plug, bodyshell or other parts. In the event of any damage, it must not be used until the damage has been repaired.
- \* The charge, battery box and battery must insert with the appointed power source of product symbol same.
- \* This product must only be used with the original collocation charger.
- \* The product is contains the functional outshoots are may be dangerous to the children.

- \* Please separate the charger and the toy before cleaning.
- \* As the front end of the antenna may be dangerous, do not aim it toward anyone's body, face or eyes.
- \* Batteries are to be inserted with the correct polarity.
- \* Use the "AA" non-rechargeable or "AA" rechargeable batteries.
- \* Non-rechargeable batteries are not to be recharged.
- \* Rechargeable batteries should only be charged under adult supervision.
- \* The rechargeable battery must be removed from the model before charging.
- \* Different types of batteries or old and new batteries are not to be mixed.
- \* Exhausted batteries are to be remove in time.
- \* The supply terminals are not to be short-circuited.
- \* Never short circuit the batteries. throw it in a fire or attempt to open their outer casings.
- \* Please remove the batteries when not in use.
- \* Please retain these instructions for future reference.

## Product Introduction

Item number: A979-B 1:18 Full Proportional Remote Control Drive Monster Truck

Vehicle size:: length 253\*width 200\*height 115MM

Wheelbase: 165MM

Wheelspan: 95MM

Wheel diameter: 71MM Wheel width: 40MM

Transmitter battery: 4 AA battery

Car battery: 7.4V1500MAH

Charge time: 2.5 hours

Playing time: About 6 minutes

Control distance: 100meters Frequency: 2.4G

Motor: 540

Speed: 70KM/H Above

Serve: 17g

Four wheels independent suspension

With front and rear differential

## Proportional R/C Using Instruction

- ① Turn left the steering wheel, the car will turn left. Turning left angle can be adjusted by the degree of wheel twisting.

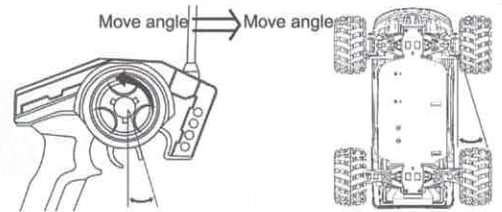

- ② Turn right the steering wheel, the car will turn right. Turning right angle can be adjusted by the degree of wheel twisting.

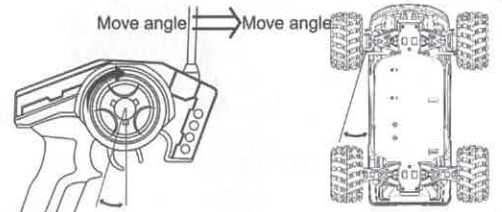

- ③ Pull the throttle trigger backward, the car will forward. Adjusting the angle of throttle trigger can adjust forward speed of the car. During the car forward, quickly push the trigger forward to stop it.

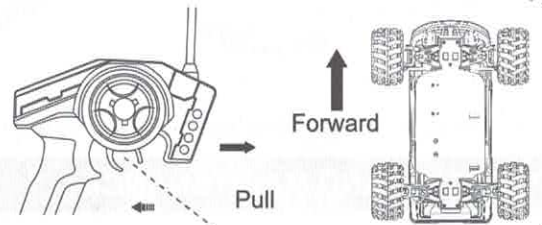

- ④ Loosen the trigger to make it return the neutral position when brake. Push the throttle trigger forward, the car will backward. Adjusting forward angle of throttle trigger adjust backward speed of the car.

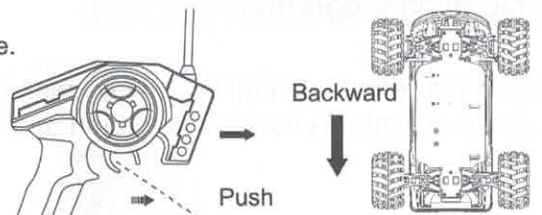

## Introduce the common tools and assemble the electron parts

### Tools needed for assembly

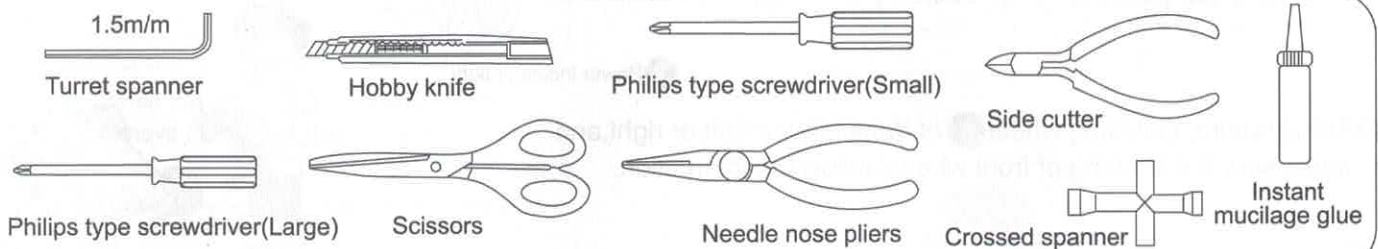

## Charge caution

### CHARGING BATTERY

- 1) Please firstly check and confirm input voltage of the charge is consistent with local voltage, output voltage of the charge is consistent with battery voltage.
- 2) Battery must be used up before you charge, Charging time is not more than 3 hours.
- 3) Be careful to make sure there is adult to control when charging.



## Assemble the electron parts

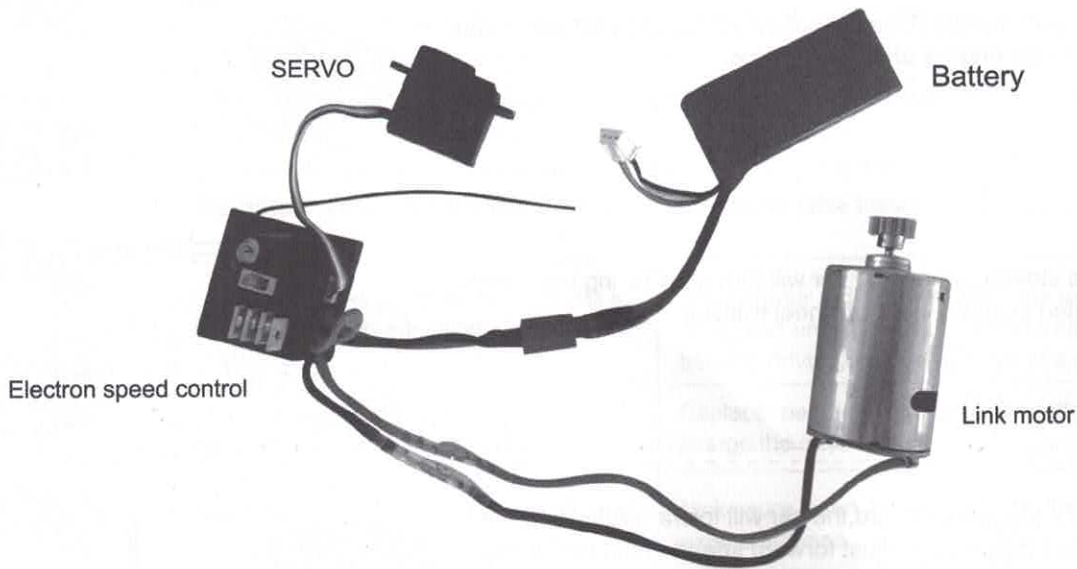

## PRACTICE AND MAINTENANCE

### Operating program

1> Open the remote control switch ①, make sure the power indicator is flashing, and then open the car.

2> Place the car on the frame or on the ground. When the wheel runs left or right, adjust the turning direction of the transmitter to fine tune ⑥ until the wheel is in the middle.

3> Slip the trigger ③ of transmitter slowly, you can observe the car whether it can go ahead or go back.

4> Turn steering adjusting wheel ④ of transmitter to left or right, and make sure the steering of front wheels follow the instruction.

5> Put the car on the ground and stand behind the back of the car. Squeeze the throttle trigger ③ of transmitter gently. If the car does not move in a straight line, you can adjust the trim ⑥ of transmitter until the car moves in a straight line.

6> OK, ready to run.

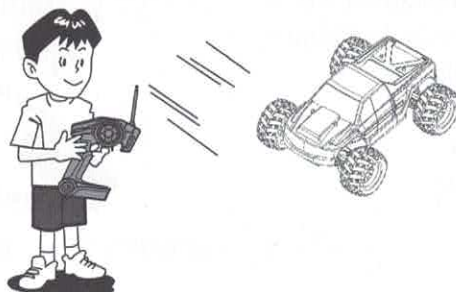
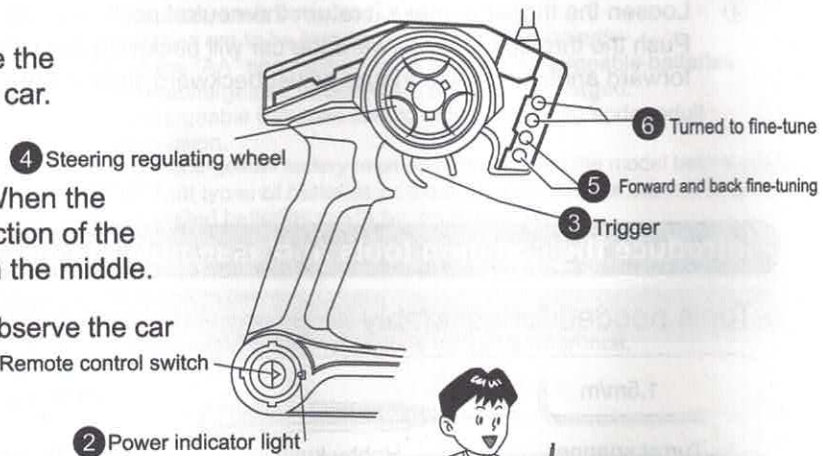

## Practice

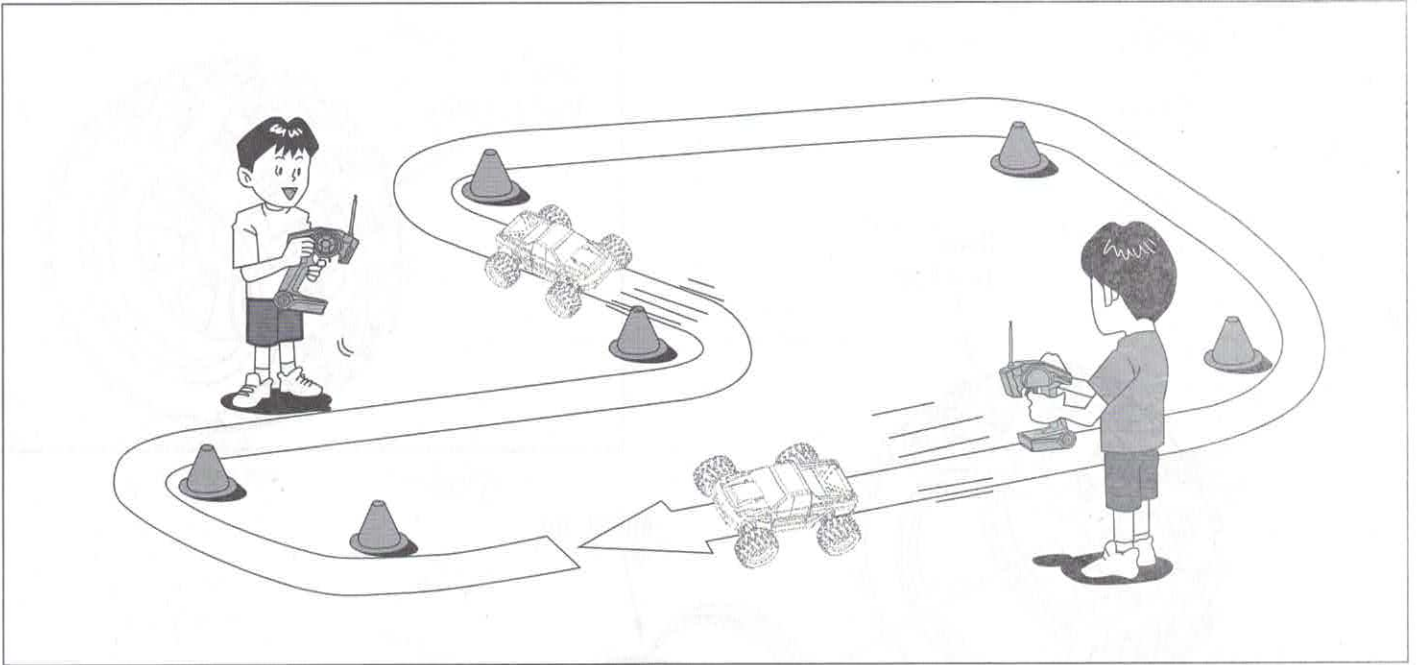

Let's practice! Make R/C car circuit at a wide and safe location using corner pylons (separately available), empty cans or such. Running fast at straight section and slow down at curved section is a basic speed control technique useful when driving R/C car.

## Maintain

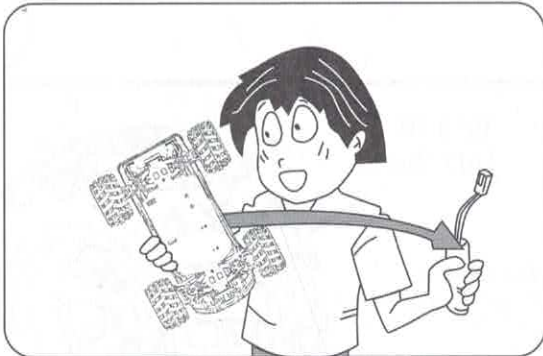

When the car is not in use, you should remove the battery from the car.

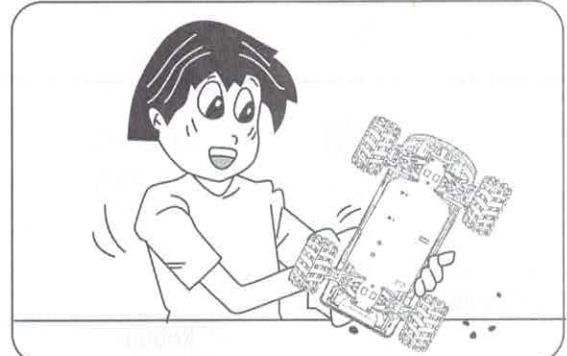

Completely remove sand, mud, dirt etc.

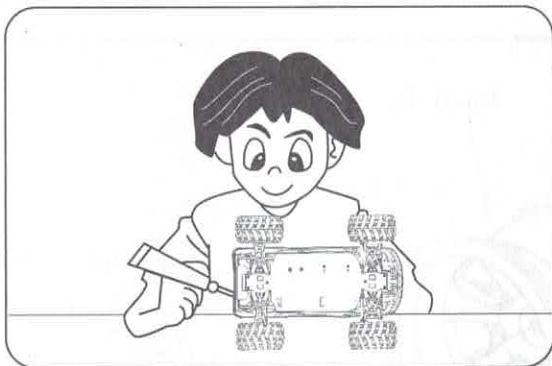

Metal outside should apply the rust prevention oil.

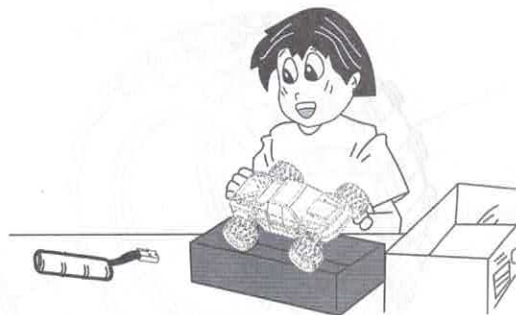

Store the car and batteries separately when not in use.

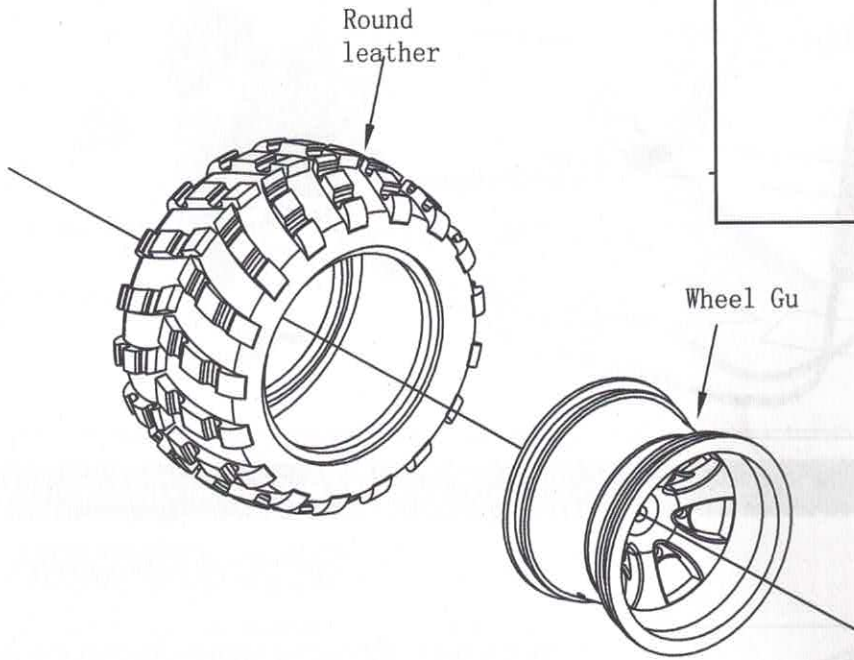

A979-02  
Right tires

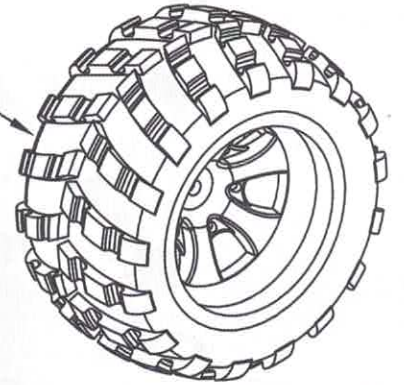

1

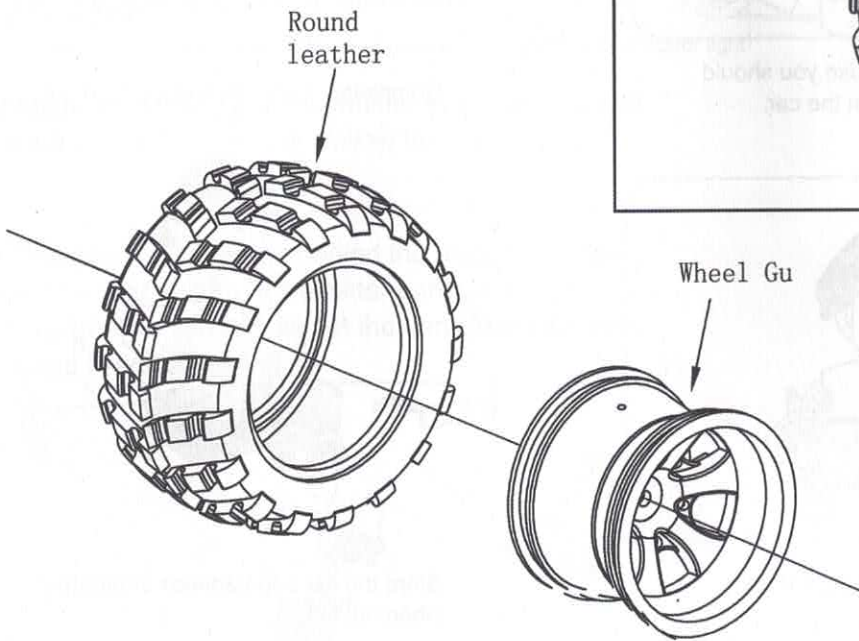

A979-01  
Left tires

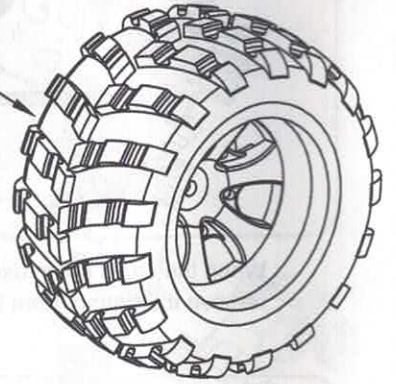

2



A959-B-12  
Front shock absorbers

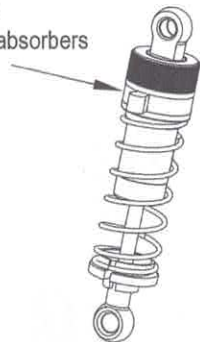

A959-B-22  
After the shock

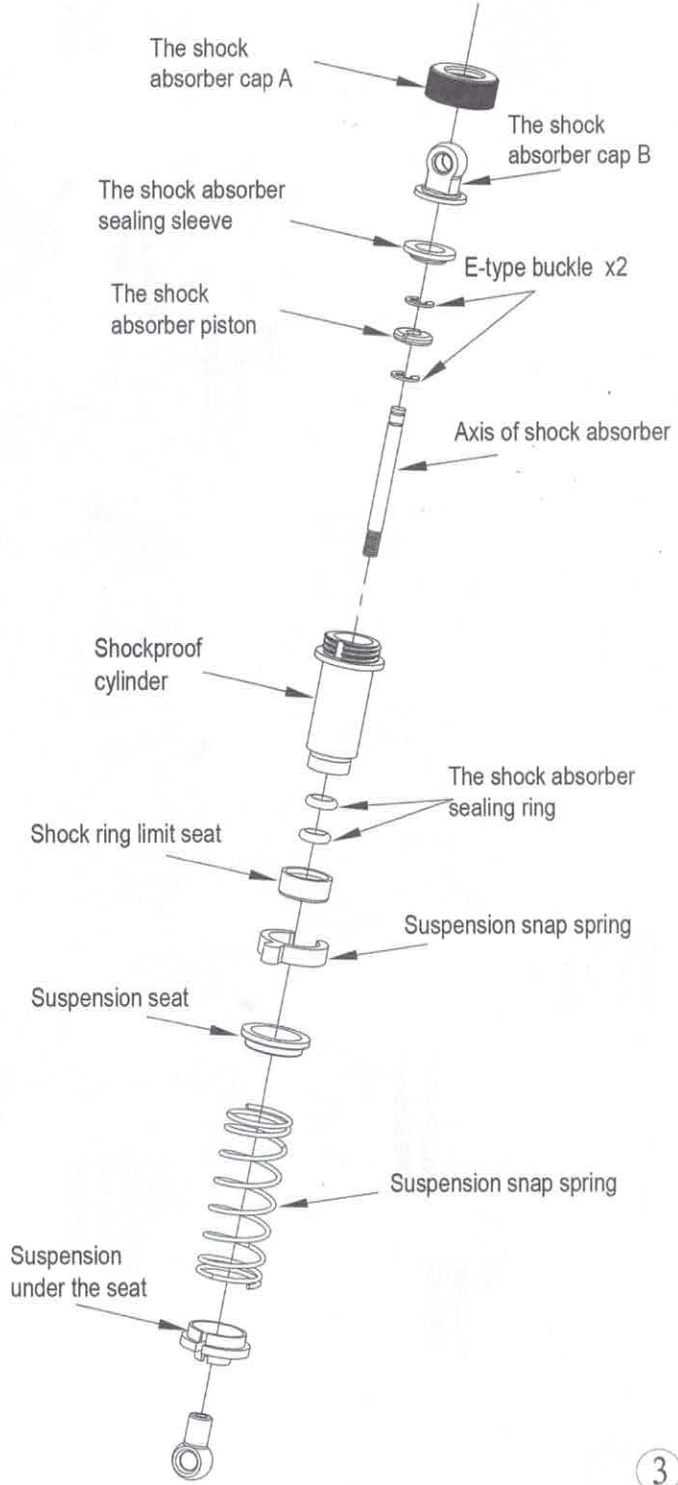
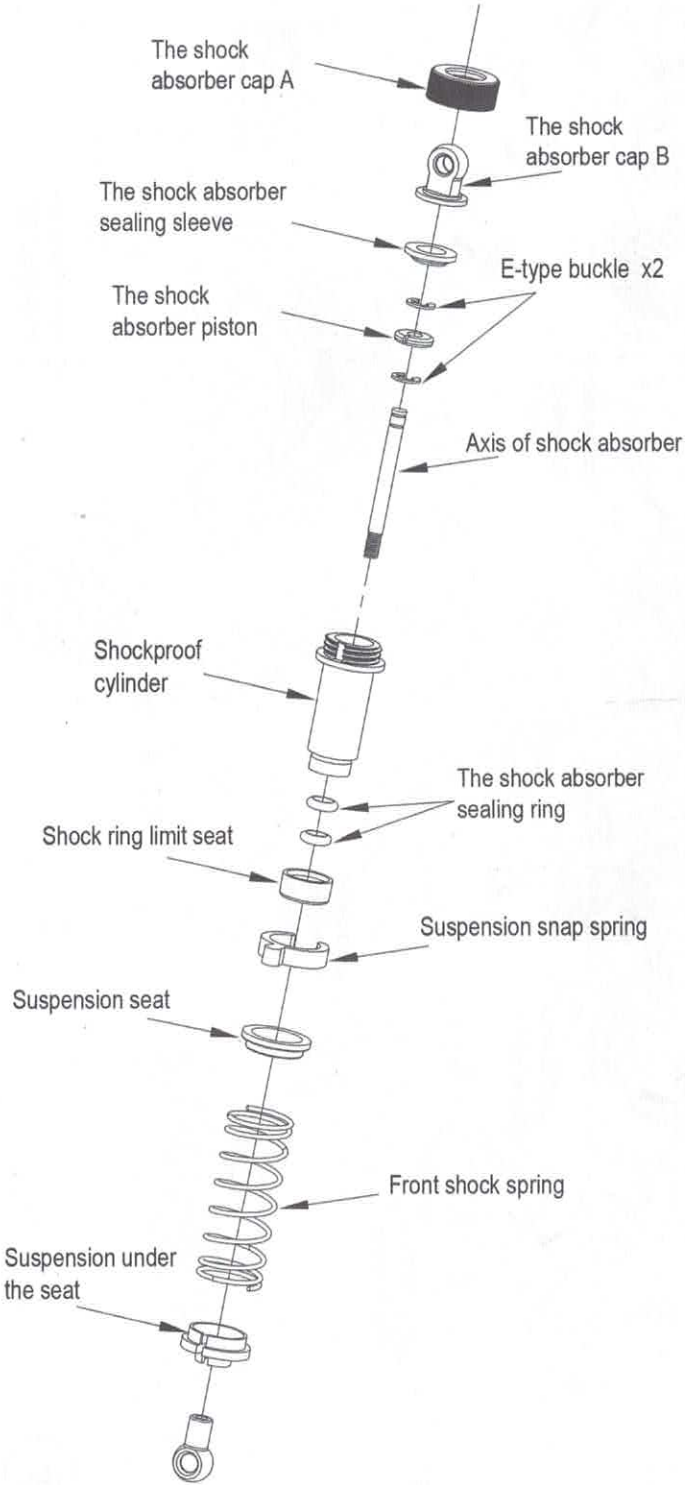
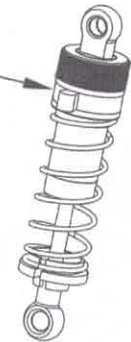

A949-09 Shock absorber plate

A949-39 Pan head tapping screws 2\*6

A949-46 Ball head screw 10.8\*4

A959-B-21 Differential cup

A949-47 Countersunk head tapping screws M2\*6

A949-35 Ball bearing 7\*11\*3

A949-23 Disc gear

A949-51 Differential pin

A949-23 Differential gear

A949-23 Differential planet gear

A949-13 Differential case

A949-12 Gearbox upper cover

A949-24 The driving gear

A949-35 Ball bearing 7\*11\*3

A959-B-20 Flat Head Machine Screw M2X6

A949-35 Ball bearing 7\*11\*3

A959-B-21 Differential cup

A949-12 Lower cover of gear box

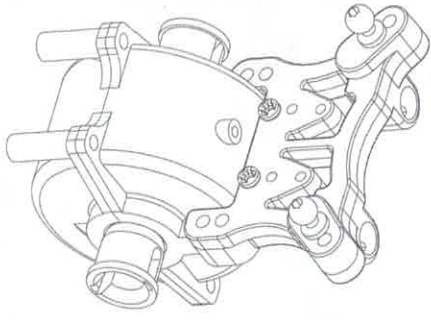

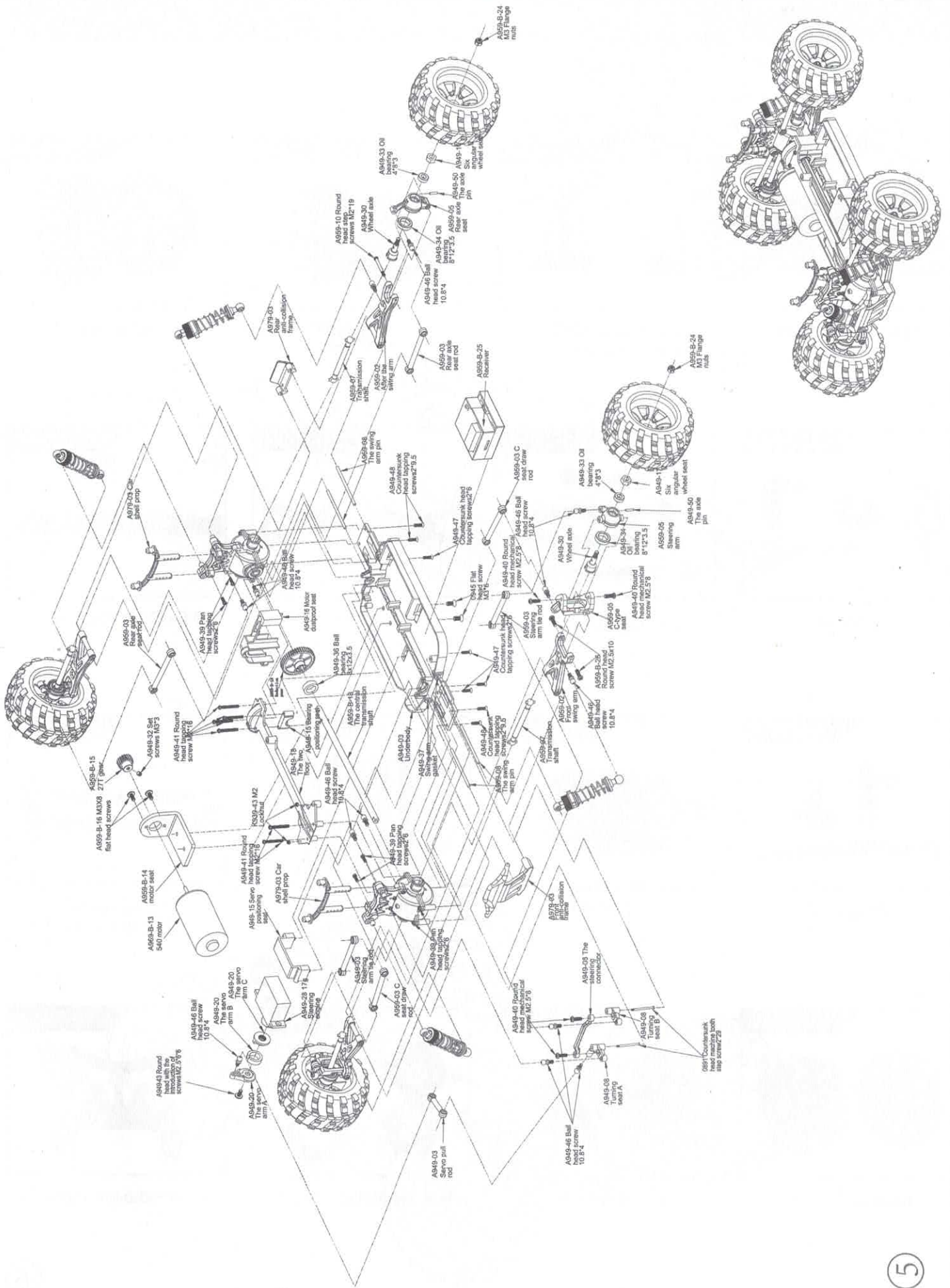

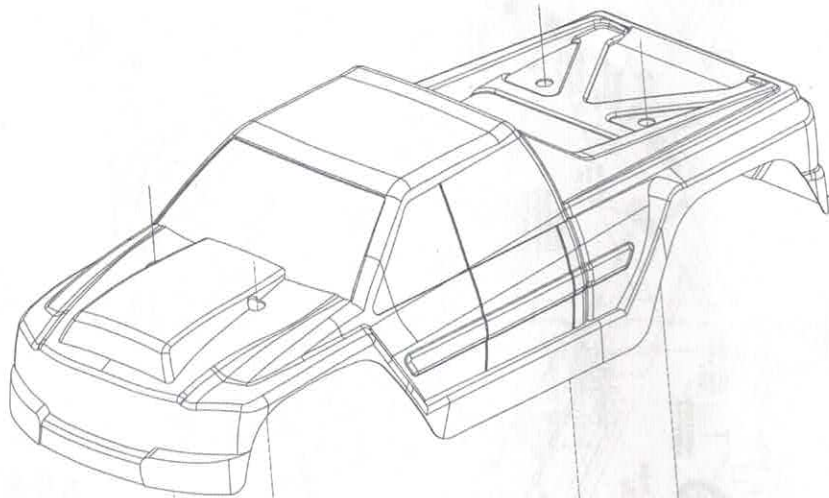
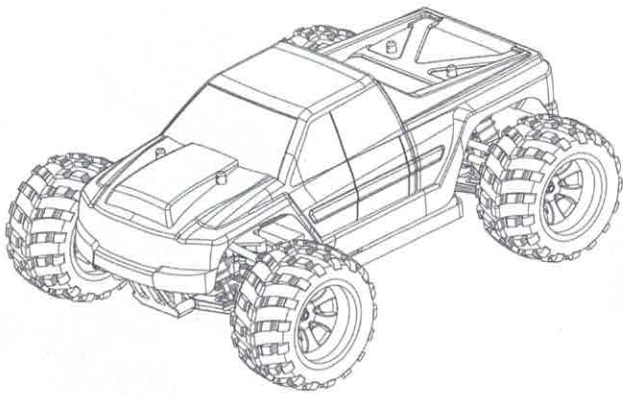

A979-B-01  
Car shell

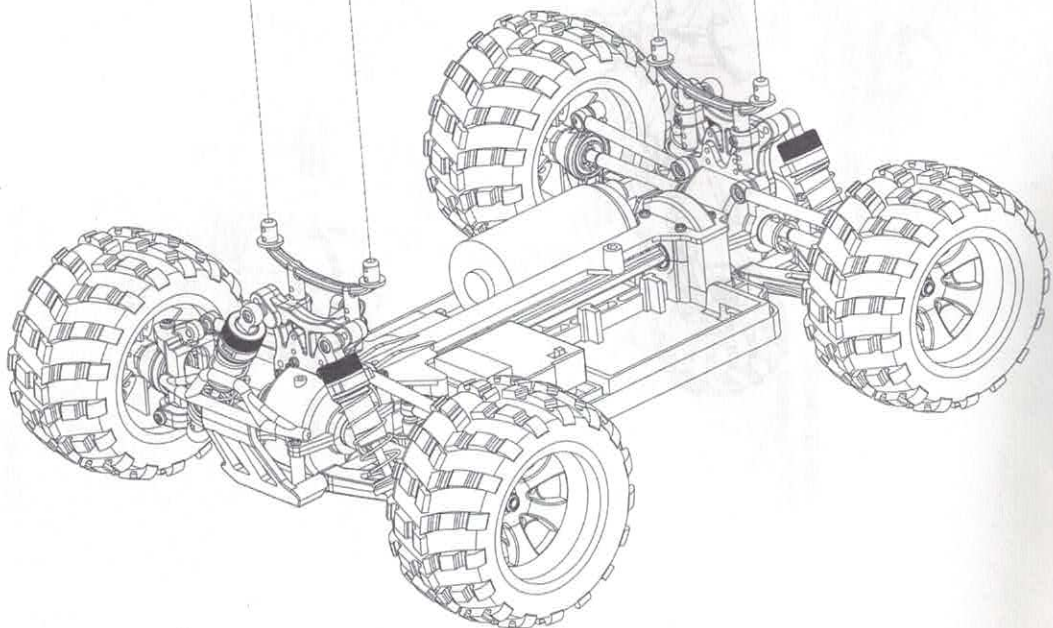

6

# Sale parts view

A979-01



Left tires

A979-02



Right tires

A979-03

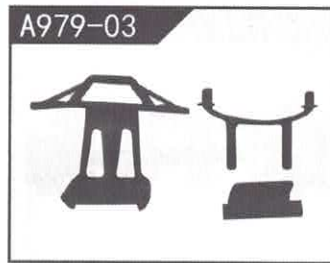

Anti-collision frame  
and car shell pillar

A979-B-01



Car shell red and white

A969-08

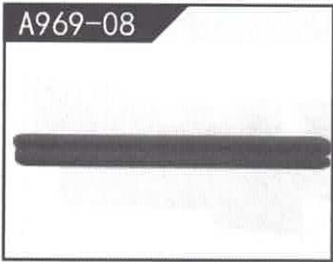

swing arm pin 2x40.8

A959-02

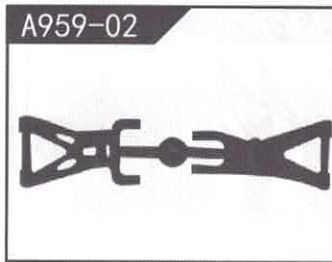

Swing arm

A959-03

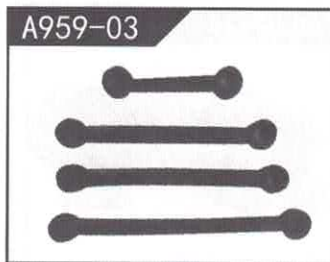

Pull rod

A959-05

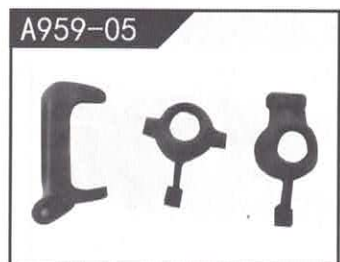

C Seat

A959-07

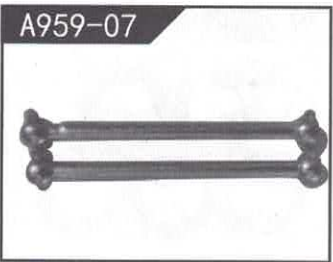

Transmission  
shaft 5.3x50.8

A959-10

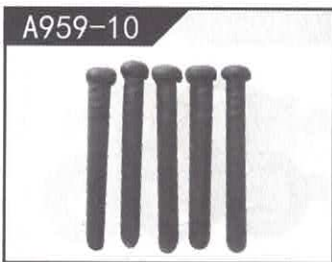

Round head screw  
level 2x19

A949-03

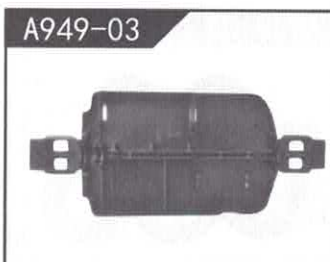

Underbody

A949-08

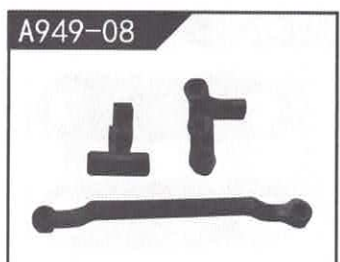

Turning seat

A949-09



Shock absorber plate

A949-11

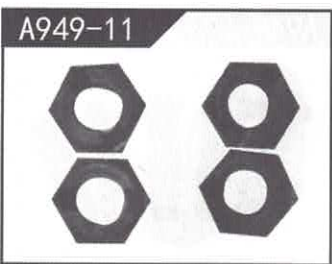

Six angular wheel seat

A949-12

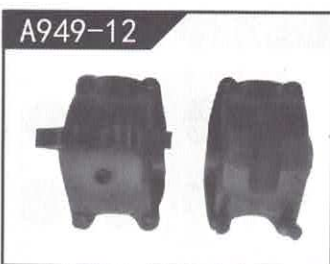

Gear box cover

A949-13

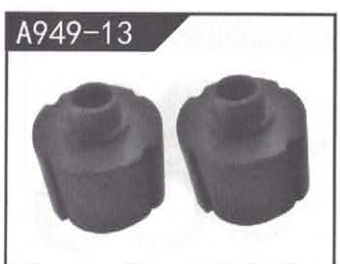

Differential case

# Sale parts view

A949-15

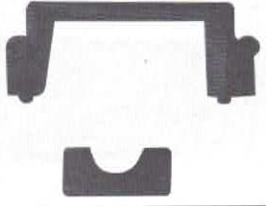

Positioning seat

A949-18



Two floor

A949-20

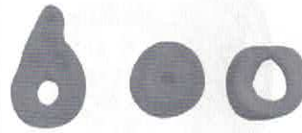

Servo arm

A949-22



Magic stick 210MM

A959-B-27



Differential mechanism

A949-24



Reduction gear

A949-28

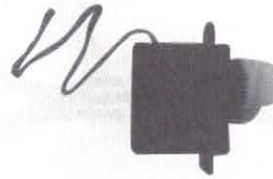

17g Steering engine

A949-30



Wheel axle 9X 25.1

A949-31

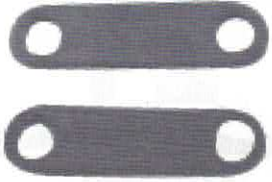

Motor fixed screw gasket

A949-33

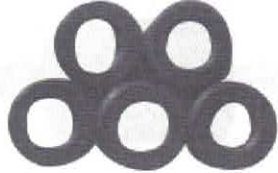

Oil bearing 4X8X3

A949-34

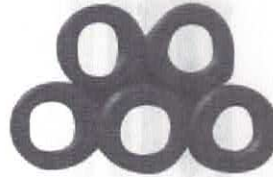

Oil bearing 8X12X3.5

A949-35

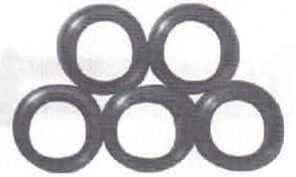

Ball bearing 7X11X3

A949-36



Ball bearing 8x12x3.5

A949-37

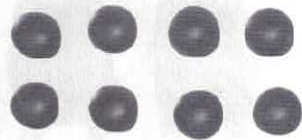

Swing arm gasket 1x5

A949-39



Pan head tapping screws 2X6

A949-40



Round head screw M2.5x8

# Sale parts view



A949-41

Pan head tapping screws 2\*16

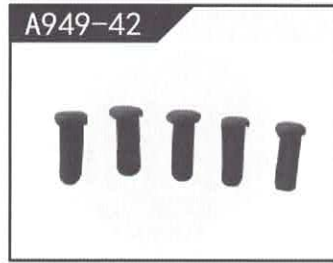

A949-42

Round head screws with dielectric 2.5X6X6

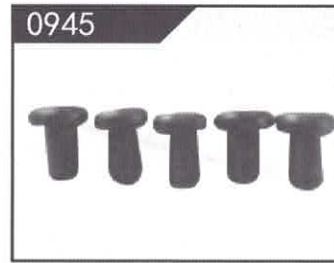

0945

Flat head screw M3X6



A949-46

Ball head screw 10.8x4

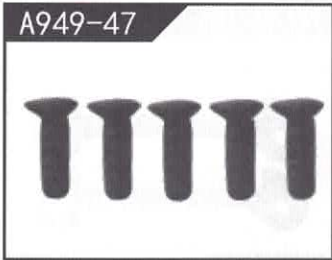

A949-47

Countersunk head tapping screws 2X6

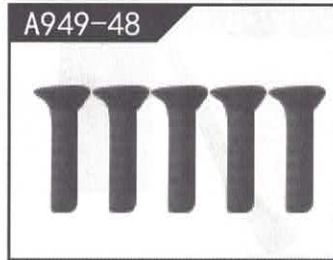

A949-48

Countersunk head tapping screws 2X9.5

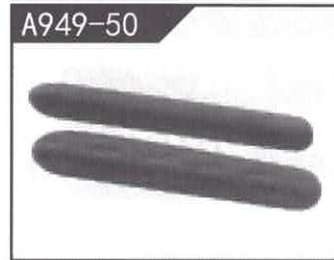

A949-50

Axle pin 1.5X7

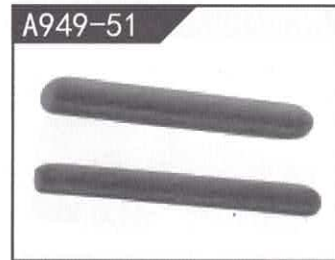

A949-51

Differential pin 1.5X16

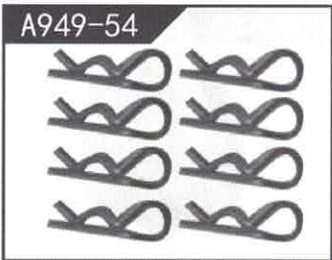

A949-54

R Pin

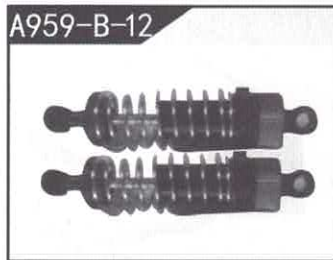

A959-B-12

Front shock absorbers



A949-57

2.4G Remote control



A949-58

Charger



A959-B-13

540 Motor



A959-B-14

Motor seat



A959-B-15

27 T gear



A959-B-16

M3x6 flat head screws

# Sale parts view

A959-B-17

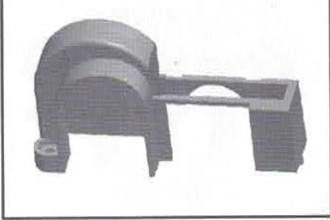

Dust cover

A959-B-18

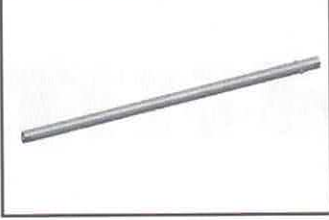

Central transmission shaft

A959-B-19



Reduction gear

A959-B-20

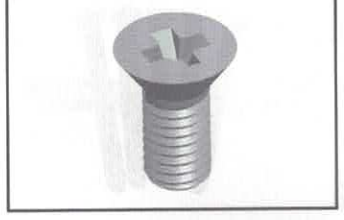

M2x6 flat head screws

A959-B-21

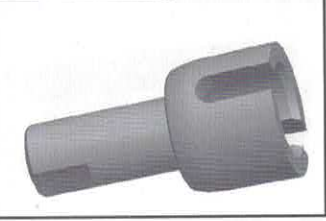

Differential cup

A959-B-22

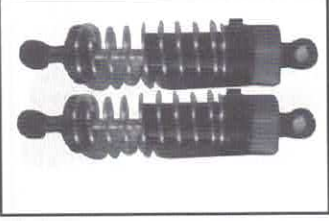

Rear shock absorber

A959-B-23



Battery

K929-02

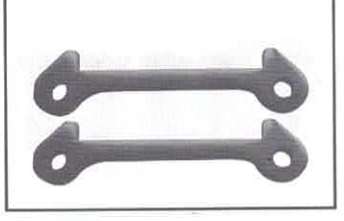

Reinforcing piece

A959-B-26

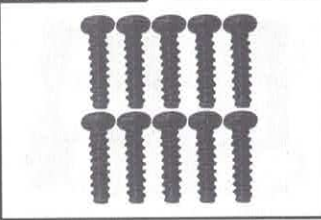

Pan Head Machine Screw  
M2.5 x 10

A959-B-24

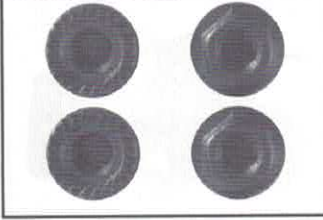

M3 flange nuts

A959-B-25

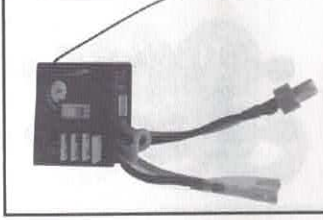

Receiver

K939-43



M2 Locknut

0891

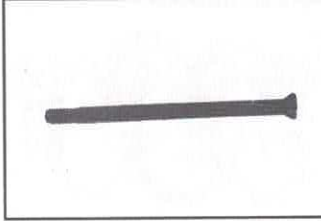

Countersunk head  
machine toothe stp  
screw2\*29